

Surface Box

APPLICATION

DataCan's Surface Box collects and stores downhole and surface data, and is considered our standard surface box. It has a weatherproof enclosure allowing the customer to use it inside or outside. The Surface Box has digital display, 20 million sample capacity, and Modbus output. DataCan offers a telemetry kit for any additional gauges required. This system is very configurable. Please contact DataCan for your specific application.

FEATURES

- Digital Display
- 20 Million Sample Capacity
- Set-Up & Download Via USB
- Modbus Output

OPTIONAL FEATURES

- Telemetry Cards
- Surface Transmitters Inputs
- RTD Thermocouple Inputs
- 4 to 20 mA Inputs

BENEFITS

The Surface Box has low power requirements so it can be run on a single car battery for months or on a small solar panel. Since the Surface Box has lots of storage, the customer does not need to get back to it right away to retrieve the data, which is great for when it is being used in an isolated area. Set-up and data download is quick and easy via a USB connection.

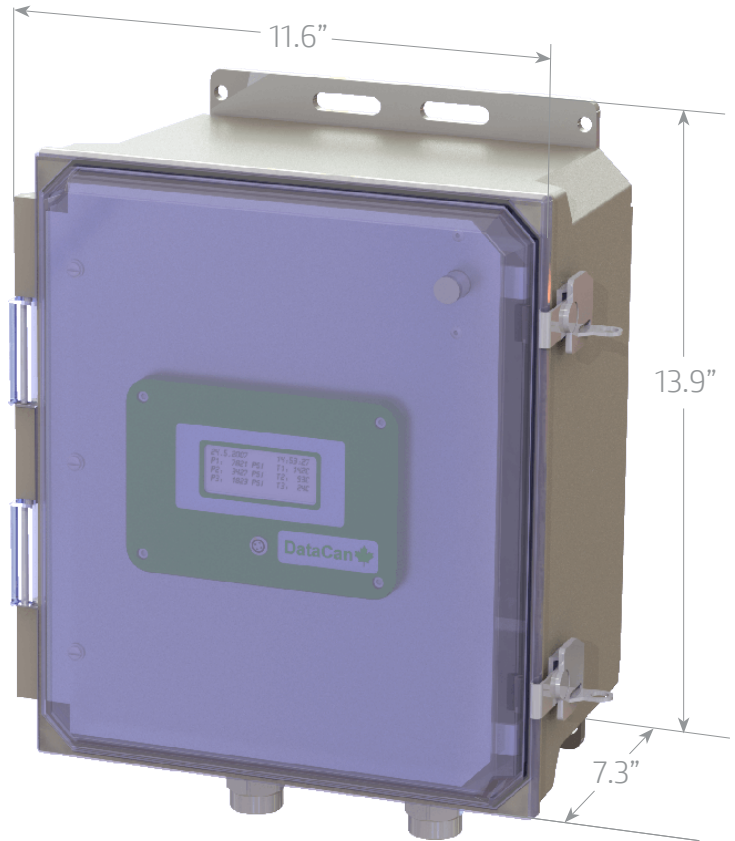

Surface Data Collection	
Description	Part No.
Logger	105421
Single Gauge Piezo	101227
Multi Gauge Piezo	103648
Multi Gauge Quartz	103649

Specifications	
Display	Pressure & Temperature
Memory Capacity	20 Million Samples
Download Via	USB
Output	RS-485 Modbus
Power In	12 V