







Features

-  Pressure
-  External Fast Response Temperature Probe
-  Casing Collar Locator
-  Compatible with a Number of Different Flowmeters
-  Easy to Use
-  Fully Welded Construction
-  Inconel 718 – NACE MR0175

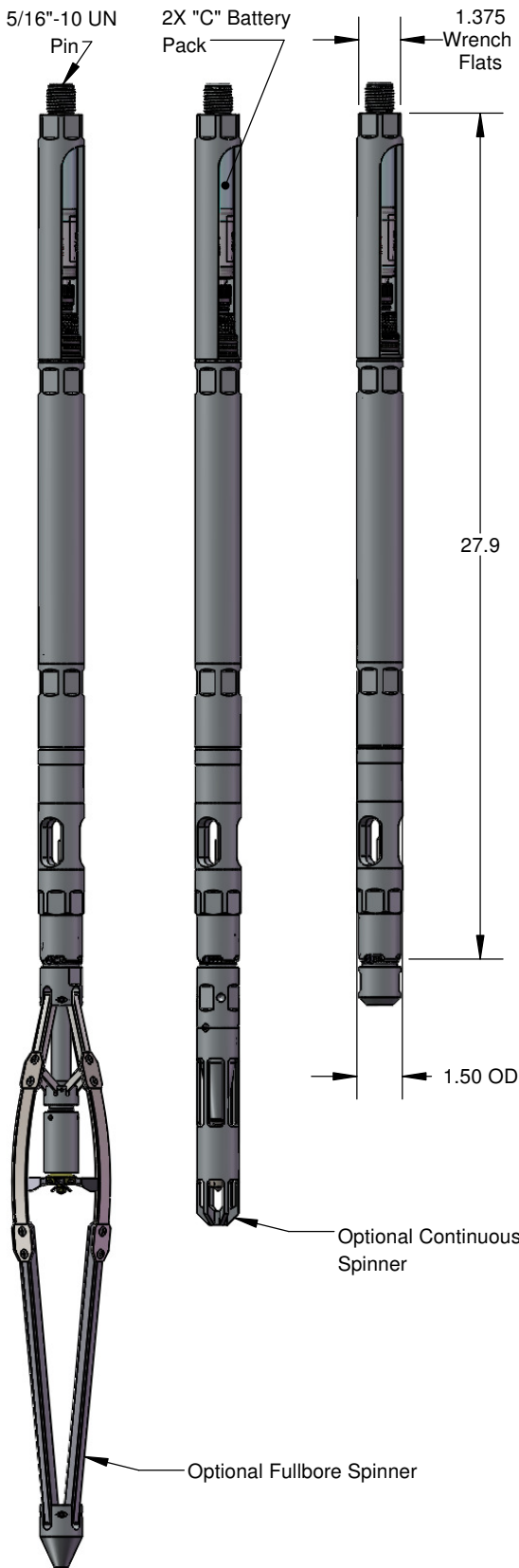

1.50" OD Mini Production Logging Tool - Inconel 718		
Pressure	Temperature	Part No.
10,000 psi	150°C	107401
15,000 psi	177°C	107425

Compatible Spinners			
Spinner Type	Size	Version	Part No.
Fullbore Spinner	5"	Standard Service	AM005WA0002
		H2S Service	AM005WB0002
	7"	Standard Service	AM005WA0008
		H2S Service	AM005WB0008
Continuous Spinner	1.375"	Standard Service	AM005WA0003
		H2S Service	AM005WB0003
	1.688"	Standard Service	AM005WA0004
		H2S Service	AM005WB0004
	2.125"	Standard Service	AM005WA0007
		H2S Service	AM005WB0007

Accessory Type	Part No.
Battery Barrel 1 X "C" Inconel 718	105047
Battery Barrel 1 x "CC" Inconel 718	105123
Pelican Case Assembly	105125
Redress Kit Viton 90	105126
Redress Kit Aflas	105127
Redress Kit Chemraz	105128

Specifications			
	Pressure	Temperature	Accelerometer
Accuracy	0.050% F.S.	0.25°C	0.1 g
Resolution	0.0003% F.S.	0.01°C	0.01 g
Drift	< 3 psi / year	< 0.1°C / year	-

Casing Collar Locator	
Detector Type	Electromagnetic

Flowmeter	
Minimum Rotation	0 rpm
Maximum Rotation	8760 rpm
Input	6 Pulses/Revolution
Max Flow Rate	500 ft/min
Output	6 pulses/revolution
Accuracy	0.02
Resolution	0.125 rps

Memory	
Sample Rate	0.1 sec to 1.82 hours
Capacity	2 Million Samples
Communication	USB