







Features

-  Value Priced
-  Fully Welded Construction
-  Hermetically Sealed
-  Dual Protection Metal to Metal Seal Design
-  Dual Axis Vibration Sensor Option
 -  Capable Of Monitoring Pump Wear

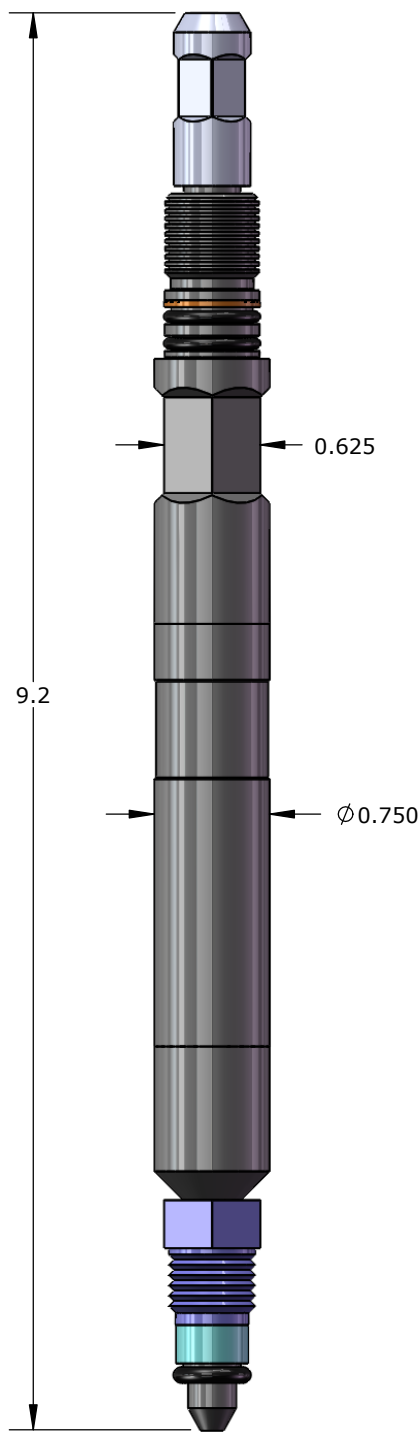

Low Temp Piezo Permanent - Stainless			
Pressure	Temperature	Wire Size	Part No.
750 psi	85 °C	1/4"	102575
1,500 psi			102576
3,000 psi			102577
6,000 psi			102578
10,000 psi			102579
15,000 psi			102580
750 psi		1/8"	102599
1,500 psi			102600
3,000 psi			102601
6,000 psi			102602
10,000 psi			102603
15,000 psi			102604

Low Temp Piezo Permanent With Vibration - Stainless			
Pressure	Temperature	Wire Size	Part No.
750 psi	85 °C	1/4"	102564
1,500 psi			102565
3,000 psi			102300
6,000 psi			102299
10,000 psi			102283
15,000 psi			102566
750 psi		1/8"	102568
1,500 psi			102569
3,000 psi			102570
6,000 psi			102571
10,000 psi			102572
15,000 psi			102573

Specifications		
	Pressure	Temperature
Accuracy Up To	0.022% Full Scale	0.25 °C
Resolution	0.0003% Full Scale	0.005 °C
Drift	< 3 psi / year	< 0.1 °C / year
Vibration Range	+/- 50 g	