









#### Features

-  8 hours @ 300°C (600°F)
-  External Fast Response Temperature Probe
-  Casing Collar Locator
-  Gamma Ray
-  Compatible with a Number of Different Flowmeters
-  0.1s Fast Sample Rate Option
-  Pressure Trigger Option
-  1.6 Million Sample Capacity
-  Inconel 718 – NACE MR0175

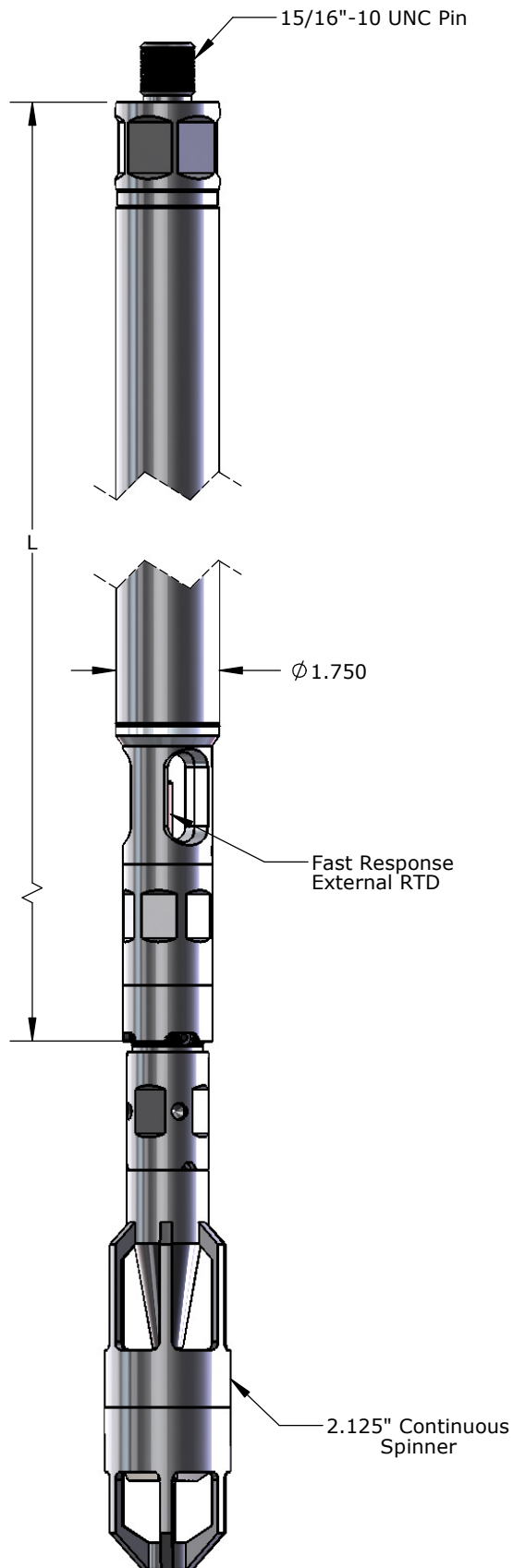

1.75" OD Geothermal PTS-GR/CCL Memory Tool - Inconel 718	
Pressure	Part No.
750 psi	108299
1,500 psi	108300
3,000 psi	108301
6,000 psi	108302
10,000 psi	108303
15,000 psi	108304
20,000 psi	108305

Compatible Spinners			
Spinner Type	Size	Version	Part No.
Fullbore Spinner	5"	Standard Service	AM005WA0002
		H2S Service	AM005WB0002
	7"	Standard Service	AM005WA0008
		H2S Service	AM005WB0008
Continuous Spinner	1.375"	Standard Service	AM005WA0003
		H2S Service	AM005WB0003
	1.688"	Standard Service	AM005WA0004
		H2S Service	AM005WB0004
	2.125"	Standard Service	AM005WA0007
		H2S Service	AM005WB0007

Accessory Type	Part No.
Pelican Case Assembly	108306
Redress Kit Viton 90	108307
Redress Kit Aflas7182B	108308
Redress Kit Chemraz 510	108309

Specifications		
	Pressure	Temperature
<b>Accuracy Up To</b>	0.022% F.S.	0.25 °C
<b>Resolution</b>	0.0003% F.S.	0.001 °C
<b>Drift</b>	< 3 psi / year	< 0.1 °C / year
Gamma Ray		
<b>Detector Type</b>	Scintillation	
Casing Collar Locator		
<b>Detector Type</b>	Electromagnetic	
Flowmeter		
<b>Minimum Rotation</b>	30 rpm	
<b>Maximum Rotation</b>	18000 rpm	
<b>Resolution</b>	0.125 rps	
Memory		
<b>Capacity</b>	1.6 Million Samples	
<b>Communication Method</b>	USB	